

PCT

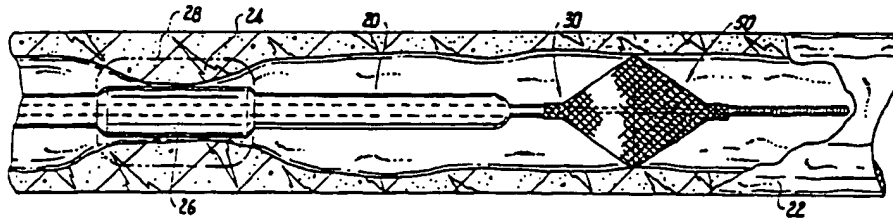
WORLD INTELLECTUAL PROPERTY ORGANIZATION  
International Bureau



INTERNATIONAL APPLICATION PUBLISHED UNDER THE PATENT COOPERATION TREATY (PCT)

(51) International Patent Classification <sup>6</sup> : A61F 2/01, A61M 25/01	A1	(11) International Publication Number: <b>WO 99/22673</b> (43) International Publication Date: 14 May 1999 (14.05.99)
(21) International Application Number: PCT/US98/23516 (22) International Filing Date: 3 November 1998 (03.11.98) (30) Priority Data: 08/963,524 3 November 1997 (03.11.97) US (63) Related by Continuation (CON) or Continuation-in-Part (CIP) to Earlier Application US 08/963,524 (CON) Filed on 3 November 1997 (03.11.97) (71) Applicant (for all designated States except US): C.R. BARD, INC. [US/US]; 730 Central Avenue, Murray Hill, NJ 07974 (US). (72) Inventors; and (75) Inventors/Applicants (for US only): GRAY, William [US/US]; 78 Quirka Lane, Corrales, NM 87048 (US). GAMBALE, Richard, A. [US/US]; 382 Dunstable Road, Tyngsboro, MA 01879 (US). (74) Agents: SWEEDLER, Michael, J. et al.; Darby & Darby P.C., 805 Third Avenue, New York, NY 10022-7513 (US).	(81) Designated States: JP, US, European patent (AT, BE, CH, CY, DE, DK, ES, FI, FR, GB, GR, IE, IT, LU, MC, NL, PT, SE).  Published With international search report.	

(54) Title: TEMPORARY VASCULAR FILTER GUIDE WIRE



(57) Abstract

A vascular filter guide wire is disclosed for directing precision placement of a catheter proximate a blood vessel lesion and filtering particulate matter dislodged by treatment of the vessel. The guide wire includes an actuating mechanism, an elongated flexible core wire having a proximal end mounted to the actuating mechanism and a distal end for insertion through a vasculature to a position downstream of the restriction. A tubular flexible shaft is slidably disposed telescopically along the core wire and includes a proximal portion affixed to the actuating mechanism in movable relation to the core wire. The guide wire includes a collapsible filter at its proximal end to the distal portion of the shaft and, at its distal end, to the core wire. The filter deploys radially in response to axial movement of the core wire relative to the shaft so that it can trap particulate matter arising from treatment of the lesion.

**FOR THE PURPOSES OF INFORMATION ONLY**

Codes used to identify States party to the PCT on the front pages of pamphlets publishing international applications under the PCT.

AL	Albania	ES	Spain	LS	Lesotho	SI	Slovenia
AM	Armenia	FI	Finland	LT	Lithuania	SK	Slovakia
AT	Austria	FR	France	LU	Luxembourg	SN	Senegal
AU	Australia	GA	Gabon	LV	Latvia	SZ	Swaziland
AZ	Azerbaijan	GB	United Kingdom	MC	Monaco	TD	Chad
BA	Bosnia and Herzegovina	GE	Georgia	MD	Republic of Moldova	TG	Togo
BB	Barbados	GH	Ghana	MG	Madagascar	TJ	Tajikistan
BE	Belgium	GN	Guinea	MK	The former Yugoslav Republic of Macedonia	TM	Turkmenistan
BF	Burkina Faso	GR	Greece	ML	Mali	TR	Turkey
BG	Bulgaria	HU	Hungary	MN	Mongolia	TT	Trinidad and Tobago
BJ	Benin	IE	Ireland	MR	Mauritania	UA	Ukraine
BR	Brazil	IL	Israel	MW	Malawi	UG	Uganda
BY	Belarus	IS	Iceland	MX	Mexico	US	United States of America
CA	Canada	IT	Italy	NE	Niger	UZ	Uzbekistan
CF	Central African Republic	JP	Japan	NL	Netherlands	VN	Viet Nam
CG	Congo	KE	Kenya	NO	Norway	YU	Yugoslavia
CH	Switzerland	KG	Kyrgyzstan	NZ	New Zealand	ZW	Zimbabwe
CI	Côte d'Ivoire	KP	Democratic People's Republic of Korea	PL	Poland		
CM	Cameroon	KR	Republic of Korea	PT	Portugal		
CN	China	KZ	Kazakistan	RO	Romania		
CU	Cuba	LC	Saint Lucia	RU	Russian Federation		
CZ	Czech Republic	LI	Liechtenstein	SD	Sudan		
DE	Germany	LK	Sri Lanka	SE	Sweden		
DK	Denmark	LR	Liberia	SG	Singapore		
EE	Estonia						

**TEMPORARY VASCULAR FILTER GUIDE WIRE****Field of the Invention**

The invention relates to vascular filters intended to capture embolic particles, by means of filtration, that may arise from the treatment of diseased blood vessels.

**Background of the Invention**

Percutaneous intravascular treatment of diseased blood vessels, such as angioplasty or stent placement procedures, may result in the dislodgment of loose plaque or thrombus which then migrate downstream. Since any such particles may become lodged in other vessels, effectively preventing blood from passing into the organ which that vessel supplies, and potentially causing serious end-organ damage which may be difficult or impossible to reverse, effective avoidance of this complication is extremely important.

One of the early methods of removing residual matter resulting from an angioplasty procedure using a balloon catheter involved maintaining the balloon in an inflated state while performing the intended intervention on the blood vessel. In this manner, much of the material could be removed without an extraneous filtering device. However, the reliability of such a procedure, especially for blood vessels supplying oxygen to the brain, necessitated substantial improvement.

Previous attempts at vascular filters have included a vena caval filter, which is permanently deployed in the vena cava via a peripheral vein in order to prevent embolisation of blood clots from the veins of the legs to the lungs, thus avoiding potentially serious and life threatening pulmonary embolism. The filter typically included a plurality of anchoring legs bent outwardly to form hooks to penetrate the vessel wall and secure the filter permanently in position. An example of such a device is disclosed in U.S. Patent No. 4,619,246.

While conventional vena caval filters work well for their intended purposes, they suffer from the disadvantages

associated with damaging the inner vessel wall through the inherent penetrating nature of the hooks, and blockage caused over time as the filter becomes endothelialized with the blood vessel inner wall or as recurrent blood clots obstruct blood flow through the filter.

In an effort to resolve the problems with vena caval filters, those skilled in the art have developed temporary filtering mechanisms that attach to an angioplasty catheter and withdraw from the vasculature following the procedure. One proposal, disclosed in U.S. Patent No. 4,723,549, discloses a collapsible wire mesh filter disposed around the distal portion of a wire guided balloon catheter. A filter balloon is positioned beneath the wire mesh and inflates radially outwardly to expand the wire mesh when inserted downstream of a stenosed blood vessel. As the vessel is treated, fine particles dislodged from the stenosis are trapped by the mesh and subsequently removed with the filter and catheter following the procedure.

A similar device and method, disclosed in U.S. Patent No. 4,873,978 includes a balloon catheter directed through a vasculature by a guide wire. The catheter mounts a strainer at its distal end that responds to actuation of a separate control wire to open and close a plurality of tines capable of retaining dislodged particles from a treated stenosis.

The temporary filter devices described above require additional lumens and/or control wires beyond those associated with the catheter guide wire to control the filtering procedure. The extra lines and wires typically create added complexity for the operator. Moreover, it is often desirable to adjust the relative spacing between the deployed filter and the stenosed area due to the potential presence of additional blood vessels proximate the stenosis. Because the conventional filters are mounted to the distal ends of the respective catheters, adjustments during the procedure typically cannot be made. Furthermore, the use of balloon catheters and stent devices involving the same procedure could not be achieved with filter protection in place.

Therefore, a need exists in the art for a temporary vascular filter which does not require additional control wires

and catheter lumens. Moreover, the need exists for such a filter in which adjustment of the filter with respect to a lesioned vessel area, and allows for the exchange of various types of devices (e.g., balloon catheters, stents, etc.), while  
5 maintaining protection against distal emboli. The temporary vascular filter guide wire of the present invention satisfies these needs.

#### SUMMARY OF THE INVENTION

The apparatus and method of the present invention  
10 minimizes the complexity associated with manipulating a vascular filter during an angioplasty or stent placement procedure by incorporating the filter on a catheter guide wire such that the guide wire performs the dual functions of guiding the catheter to a stenosed location, and filtering dislodged particles  
15 flowing downstream of the treated area. Moreover, because the guide wire operates independently of the catheter, relative spacing between the filter and the lesion location may be easily altered, and exchanges of various devices over the wire are possible.

To realize the advantages described above, the  
20 invention, in one form, comprises a vascular filter guide wire for directing precision placement of a catheter or stent proximate a lesion and selectively filtering particulate debris dislodged by treatment. The guide wire includes an actuating  
25 mechanism and an elongated flexible core wire having a proximal end mounted to the actuating mechanism and a distal end for insertion through a vasculature to a position downstream of the lesion. A tubular flexible shaft is slidably disposed  
30 telescopically along the core wire. The shaft includes a proximal portion affixed to the actuating mechanism in movable relation to the wire proximal end, and a distal portion disposed inwardly from the core wire distal end for placement downstream of the lesion. A collapsible strainer coupled to the shaft  
35 distal portion is operable, in response to relative displacement between the shaft and the core wire, to radially extend outwardly within the vasculature so that it can trap particulate matter arising from the treatment of the lesion.

In another form, the invention comprises a catheter system for treating a lesion within the vasculature. The catheter system includes a catheter having a lesion treatment device and a vascular filter guide wire for directing the catheter to the lesion. The guide wire includes a collapsible filter for deployment downstream of the catheter to trap particulate matter dislodged from the lesion during the treatment.

In yet another form, the invention comprises a method of filtering particulate debris from a vasculature caused by treatment of a lesion with a catheter having a lesion treatment portion, the catheter being guided to the location of the lesion by a vascular filter guide wire having a core wire, a slidable shaft, and a collapsible filter mounted on the shaft and deployable upon relative displacement between the core wire and the shaft. The method includes the steps of first guiding the vascular filter guide wire through the vasculature along a predetermined path to a lesion such that the filter is disposed downstream of the lesion. The next step involves deploying the filter radially outwardly by shifting the shaft relative to the core wire. Then, the catheter is run over the guide wire along the predetermined path to position the lesion treatment portion of the catheter proximate the lesion. The method continues by treating the lesion according to a predetermined procedure then maintaining the filter in a deployed position until the risk of particulate matter is substantially eliminated. The catheter is then withdrawn from the vasculature and the filter retracted radially inwardly by shifting the shaft back to the original position. The method then concludes with the step of removing the guide wire from the vasculature.

One embodiment of the invention comprises a vascular filter for controllably expanding within a blood vessel to trap particulate matter loosened from treatment of a lesion. The filter is responsive to relatively shiftable control elements to expand and retract and includes a braid comprising a composite metallic/polymeric material. The material includes a plurality of metallic filaments mounted to the respective shiftable shaft and core wire to define a support structure and a polymeric mesh interwoven with the metallic filaments to define a strainer.

Another form of the invention comprises a method of fabricating a vascular filter. The method includes the steps of first selecting a mandrel having a plurality of consecutively connected forms and weaving a continuous layer of braid over the consecutively connected forms. The method proceeds by bonding the braid filaments at spaced apart sections between respective forms and separating the respective braided forms at the bonded sections. The forms are then removed from the layer of braid.

Other features and advantages of the present invention will be apparent from the following detailed description when read in conjunction with the accompanying drawings.

#### BRIEF DESCRIPTION OF THE DRAWINGS

FIG. 1 is an enlarged, partial sectional view of a catheter system of the present invention deployed within a blood vessel;

FIG. 2 is a partial longitudinal view of a guide wire in a retracted position according to a first embodiment of the present invention;

FIG. 3 is a partial longitudinal sectional view along line 3-3 of FIG. 2;

FIG. 4 is a partial longitudinal sectional view similar to FIG. 3 but in a deployed orientation;

FIG. 5 is an enlarged view of detail 5-5;

FIG. 6 is a longitudinal view of a filter construction according to an alternative embodiment of the present invention;

FIG. 7 is a longitudinal view of a filter construction according to yet another embodiment of the present invention;

FIG. 8 is a mandrel system for use in the method of the present invention;

FIG. 9 is a block diagram illustrating steps in preparing the mandrel of FIG. 8;

FIG. 10 is a block diagram illustrating steps in fabricating the filter of the present invention;

FIG. 11a - 11g are views of various stages of construction corresponding to the steps of FIG. 10;

FIG. 12 is a partial longitudinal sectional view of a guide wire in a retracted state according to a second embodiment of the present invention;

FIG. 13 is a partial view of the guide wire of FIG. 12 in an extended state;

FIG. 14 is an axial view along line 14-14 of FIG. 13;

FIG. 15 is an axial view similar to FIG. 14 and showing an alternative strut arrangement; and

FIG. 16 is an axial view similar to FIG. 14 and showing an alternative strut arrangement.

#### DETAILED DESCRIPTION OF THE INVENTION

With reference to Figure 1, percutaneous angioplasty or stent placement techniques enable operators to minimize trauma often associated with more invasive surgical techniques. This is possible through the use of a thin catheter 20 that advances through the vascular system to a predetermined blood vessel 22 having a lesion such as a stenosis 24 blocking the flow of blood therethrough. Typically, the catheter includes a lesion treatment device such as a balloon 26 or stent (not shown) for positioning coaxially within the lesion. Once positioned, the balloon or stent radially expands, as shown at 28, to exert a radially outwardly directed force against the material and initiate dilation thereof.

In order to reach the lesioned area, however, the catheter must be able to follow a trackable path defined by a catheter guide wire. In accordance with a first embodiment of the present invention, a catheter guide wire, generally designated 30, provides a trackable path for a catheter and includes a distally disposed collapsible filter 50 to trap particulate matter dislodged by the catheter 20 during treatment of the stenosis.

Referring now to Figures 2 through 5, the guide wire 30 includes a proximal section 32 comprising a solid core wire 34 having a wave-shaped proximal end 36 (Figure 2). A tubular shaft 38 is coaxially disposed around the core wire and includes an outer diameter equal to the nominal size of the guide wire. The inner diameter of the tube is sized to form a friction fit with the core wire proximal end when slid thereover during insertion and removal of the guide wire. The shaft functions to deploy and retract the filter device, and to guide and support the catheter 20, and to smoothly transmit rotation from the



proximal section 32 to an intermediate section 40. Preferably, the shaft comprises a polyimide tube or hypotube. In some applications, where relatively long lengths are required, an extension (not shown) may be attached to the proximal section to increase the length up to three meters.

The intermediate section 40 extends axially from the proximal section 32 and generally comprises an extension of the shaft 38 to coaxially surround the core wire 34. The core wire is formed distally with a primary tapered portion 42 defining an annular shoulder 44 for mounting a coiled spring 46.

With further reference to Figures 2 through 5, the filter 50 comprises a braided basket 52 having respective inner and outer braid layers 54 and 56 (Figure 5) that, in one embodiment, serve as supports for a fine filter mesh 58. The supports expand the basket radially outwardly with the filter axial ends compressed inwardly, and radially retract the basket with the ends tensioned outwardly. The fine mesh 58 (Figure 5) is interposed between the inner and outer supports along a distal-half portion 60 of the basket to prevent particulate matter from flowing through the blood vessel downstream of the treated stenosis. It is contemplated that the size of the pores of mesh 58 may be in the range of 40 to 500 microns. The meshed distal-half of the filter forms a collection cavity 62 for the material such that when retracted, the material is prevented from escaping the filter.

The proximal end of the filter basket is bonded (e.g. adhesively or by soldering) to the shaft 38 which may be inserted between braid layers 54 and 56.

The distal extremity 57 of basket abuts a flexible coil spring 66 that coaxially surrounds the tip of the core wire 34. The guide wire distal tip is tapered and terminates in a hemispherically shaped tip 72 which is also bonded (e.g. by soldering) to the tip. The guide wire distal tip may be pre-formed into a "J" configuration (not shown) to aid in advancing the guide wire 30 through the vasculature.

With particular reference to Figure 6, the preferred embodiment of filter 50 according to the present invention includes a braid comprising a composite metallic/polymeric material, eliminating the necessity of a separate mesh layer. In

such an embodiment, a plurality of metallic filaments 82 provide structural support to the assembly for deploying and collapsing the filter. Polymeric filaments 84 are located on the distal half of the braid only, to provide a filtration cone 86. The  
5 dual materials, braided simultaneously, provide a pic density which will result in filtration spacing of approximately 40 to 500 microns for filtration, at a metal to polymeric ratio of approximately 1:4.

10 In yet another embodiment of a filter according to the present invention, generally designated 90 and illustrated in Figure 7, the filtering medium is wrapped in a cylinder 92 with a closed distal end 94 and a flared proximal end 95. Flaring of the proximal end may be effected by applying heat and pressure to the material thereby increasing the surface area and causing  
15 the material to bow radially outwardly. The cylinder is formed with longitudinal pleats (not shown) that are more flexible and collapsible than a straight cone configuration.

Referring now to Figures 8 and 9, fabrication of the filter 50 may be performed in accordance with a series of  
20 process steps as described below. Initially, a mandrel 96 (Figure 8) with a series of molded forms 97 and 98 is prepared by selecting a mandrel of appropriate length, at step 100 (Figure 9), and providing a plurality of crimps 101 (Figure 8) on the mandrel at intervals of approximately two to three  
25 inches, at step 102. The process proceeds by placing molds over the crimps, at step 104, filling the molds with a dissolvable compound, at step 106, curing the compound, at step 108, and removing the molds, at step 110. Suitable materials for molding include water soluble plastics such as polyethylene oxide,  
30 chemical soluble plastics such as styrene or PVC, and other water soluble materials such as sugar cubes, or gypsum based compounds. Molded forms may be continuously fabricated along the length of the crimped mandrel sections to maximize production efficiency. Another suitable method envisioned is to  
35 individually form the molds and bond to straight mandrels.

Referring now to Figures 10 and 11a-g, following preparation of the mandrel 96, the mandrel itself is selected for the method of fabricating the filters, at step 112. The method progresses by selecting a braider, at step 114, and

braiding the inner layer 54 (Figure 11a), at step 116, over the mandrel form system. Because of the convenient serially connected system of forms on the mandrel, the braider progressively weaves a continuous layer of braid over the consecutively connected forms. After the braid is applied, the mandrel is removed from the braider, at step 118, so that a curable epoxy may be applied to define an adhesive joint 119 (Figure 11b) along spaced apart sections of the braid between forms. This step bonds braid filaments together, at step 120, so that subsequent separation of the forms minimizes deformation of the braid.

A center section 121 (Figure 11c) of each braid is then cut, at step 122, and a prefabricated filter 123 (Figure 11d) installed over one side of each form, at step 124. The individual segments are then reconnected, at step 126, by splicing a section of heat shrink tubing 127 (Figure 11e) over each severed joint.

After the segments are re-connected, the mandrel assembly is then re-installed into the braider for braiding of the outer basket 56 (Figure 11f), at step 128. Following braiding, the mandrel is removed from the braider, at step 130, with the braid filaments bonded together to form a joint 131 (Figure 11g), at step 132. The mandrel is then cut at approximately one millimeter on the outside end of the adhesive, at step 134. At this point, the molded form may be dissolved by an appropriate solvent, at step 136, and the mandrel removed, at step 138. Lastly, a polyimide sleeve is bonded, at step 140, to the end opposite the filter.

The alternative filter embodiment 80 may be fabricated similar to the procedure above with only minor variations. Conveniently, because of the composite nature and relatively high pic density of the metallic/polymeric braid, only one braiding step is required. After the final braid, the polymeric strands at the proximal end are mechanically or thermally cut away, and the filaments fused at the large diameter of the formed cone to form the collection cavity and to allow for greater blood flow.

In operation, the guide wire 30 may be advanced through a vascular system in any conventional manner to

establish a path for the catheter to track over. Generally, as shown in Figure 1, the guide wire is inserted through the lesion and disposed downstream of the lesion 24 a variably selected distance. The distance selected by the operator may be  
5 conveniently adjusted merely by further advancing or slightly withdrawing the guide wire. This provides the highly desirable capability of enabling the operator to independently adjust the selected distance to preclude the possibility of embolic  
10 material progressing through a branch path between the lesion and the filter. The catheter 20 is then inserted along the guide wire to access the treatment area. Typically, image scanning techniques aid in the exact positioning of the catheter relative to the lesion such that the lesion treatment device will have maximum effectiveness.

15 The filter may then be deployed by actuating an actuating mechanism (not shown) coupled to the core wire 34 for axially moving the shaft 38 relative to the core wire. As the shaft advances axially along the core wire in the distal direction, the filter basket 52, having its distal end 57  
20 attached to the fixed core wire and its proximal end connected to the shaft, compresses axially and expands radially outwardly against the inner walls of the blood vessel. In its expanded state, the filter 50 collects any plaque that may have loosened and become dislodged from the treated area.

25 Once the treatment concludes, and the catheter is withdrawn from the body, the filter is retracted radially inwardly by shifting the shaft back to its original position. As the filter retracts, the collection cavity 62 traps any material strained against the filter layer. The guide wire itself is  
30 then carefully withdrawn from the vasculature.

Referring now to Figures 12 through 16, a temporary filter guide wire according to a further embodiment of the present invention is shown, and generally designated 200. The guide wire generally includes a proximal end 202 having an  
35 actuating mechanism 208, an intermediate portion 220 including a housed collapsible filter element 222, and a flexible distal end 240.

With particular reference to Figure 12, the proximal end 202 includes a solid stainless steel core wire 204 having a

diameter, for example, of approximately 0.0075 inches and slidably confined coaxially by an elongated shaft 206. The shaft may include, for example, an inner diameter of approximately 0.010 inches and an outer diameter of approximately 0.014 inches. The proximal tip of the core wire nests within the handle mechanism 208 that includes a rotatable handle element 209 having a formed central blind bore 210 and a threaded hollow shank 212. A fixed threaded base 214 having a throughbore 216 receives the proximal portion of the shaft 206 and rotatably engages the handle element to define the actuating mechanism.

Referring now to Figures 12 and 13, the core wire 204 and the shaft 206 extend longitudinally to define the intermediate portion 220 of the guide wire. The filter element 222 is mounted to the intermediate portion and includes an intermediate quad filar spring 224 of approximately 0.002 inch diameter wire that extends approximately three to seven centimeters from the end of the shaft, depending on the application. The respective ends of four wires comprising the quad spring are unwound, straightened, and outwardly biased approximately forty-five degrees from the spring axis at spaced apart radial locations to define a plurality of umbrella shaped filter struts 226. These struts form the support structure for the filter. As shown in Figures 14, 15, and 16, the strut spacing may conveniently take on a variety of configurations depending on the particular application desired. Lashed to the struts is a fine wire mesh 228 of approximately 0.001 inches thick within 40 to 500 micron pores for straining particulate matter from the bloodstream.

Further referring to Figure 12, the radial exterior of the distal portion of the core wire 204 carries a bonded housing or pod 230 having an axially open mouth 232 slightly larger in diameter than the diameter of the filter in a closed configuration. The mouth opens into a cavity sufficiently sized to fully enclose the filter during insertion or withdrawal of the guide wire. The pod would also have a rounded inward edge at its proximal opening so as to envelop the filter when retracted and prevent unintentional engagement of a stent or catheter upon withdrawal. The pod may be fabricated out of a

spring material wound in the opposing direction as the spiral struts to improve the sliding of the two surfaces. Other options include a lubricious plastic such as polyethylene.

5 The distal end 240 of the guide wire 200 comprises an extension of the core wire 204 from a bonded distal joint and surrounded by a distal spring member 242 that bonds to and projects outwardly from the distal side of the filter housing 230. The distal end terminates in a tip 244 that typically takes on a pre-formed "J" shape (not shown) for steering  
10 purposes through the vascular system.

Operation of the second embodiment proceeds in much the same way as that of the first embodiment, with the guide wire 200 first directed through the vasculature, followed by tracking with a treating catheter. Like the first embodiment,  
15 the guide wire 200 is advantageously adjustable in the blood vessel independent of the catheter, allowing a variable selected distance between the location of the stenosis and the filter. However, the way in which the filter 222 expands and retracts differs somewhat from the previously described embodiment.

20 With the handle mechanism 208 in a normally open configuration, the operator turns the rotatable element 209 to incrementally drive the core wire 104 axially with respect to the shaft 206. The relative axial displacement of the core wire causes the filter housing 230 to become disengaged from the  
25 filter struts 226. Because of the spring biased nature of the filter struts 226, as the filter exits the housing, the struts expand radially outwardly against the blood vessel wall such that the wire mesh spans the vessel diameter. In its extended state, the filter allows bloodflow to continue through the  
30 vessel while dislodged material becomes entrapped in the wire mesh for collection in the cavity.

Once the lesion treatment procedure is complete, and the necessity for filtering has completely diminished, the handle mechanism is actuated to pull the core wire back to its  
35 original position. This activity causes the housing mouth to re-engage the filter struts and urge the struts radially inwardly as the housing encloses the filter. With the filter fully retracted, the streamlined guide wire may be easily and safely withdrawn from the body.

Those skilled in the art will appreciate the many benefits and advantages afforded the present invention. Of relative importance is the feature that avoids any additional control wires, beyond the guide wire itself, in order to expand and retract the filter. Not only does this minimize the number of components necessary to practice the invention, but the angioplasty procedure itself is made safer for the patient.

Additionally, the present invention provides the capability of adjusting the distance between the filter and the catheter lesion treatment device in vivo, eliminating the need to withdraw the guide wire or catheter for distance adjustment should the relative spacing be inadequate.

The filter itself, in one embodiment, provides substantial manufacturability benefits by requiring only a single braiding step. Consequently, braiding additional filter layers adding to the device's complexity are eliminated. By minimizing the process steps required to fabricate the filter, costs involved in manufacture are greatly reduced.

Moreover, the method of fabricating filters according to the present invention offers added efficiencies in manufacture due to the production line processing scheme. Employing such a scheme serves to dramatically improve the throughput rate of filters to minimize overall costs.

While the invention has been particularly shown and described with reference to the preferred embodiments thereof, it will be understood by those skilled in the art that various changes in form and detail may be made therein without departing from the spirit and scope of the invention.

For example, the invention may be used in any intravascular treatment utilizing a guide wire where the possibility of loosening emboli may occur. Although the description herein illustrates angioplasty and stent placement procedures as significant applications, it should be understood that the present invention is in no way limited only to those environments.

## WHAT IS CLAIMED IS:

- 1           1. A vascular filter guide wire for directing placement  
2 of a catheter with respect to a blood vessel lesion and  
3 filtering particulate matter dislodged by treatment of said  
4 vessel, said guide wire including:  
5            an elongated flexible core wire having a proximal end  
6 and a distal end for insertion and steering through a patient's  
7 vasculature to a position downstream of said lesion;  
8            a tubular flexible shaft slidably disposed along said  
9 core wire, said shaft including a proximal portion and a distal  
10 portion disposed proximally of said core wire distal end for  
11 placement downstream of said lesion; and  
12            a collapsible filter coupled at its proximal end to  
13 said distal portion of said shaft and at its distal end to said  
14 core wire, said filter operable in response to the relative  
15 displacement between said shaft and said core wire to radially  
16 extend outwardly within said vasculature and trap particulate  
17 matter arising from the treatment of said lesion.
- 1           2. A vascular filter guide wire according to claim 1 and  
2 further including:  
3            a locking mechanism to maintain said filter in a  
4 deployed position for particulate filtration during lesion  
5 treatment.
- 1           3. A vascular filter guide wire according to claim 1  
2 wherein:  
3            said core wire includes a filter housing for confining  
4 said filter in a closed configuration.
- 1           4. A vascular filter guide wire according to claim 3  
2 wherein:  
3            said housing is formed in a frusto-conical  
4 configuration and axially disposed on said core wire, said  
5 housing including an oversized-in-diameter mouth opening axially  
6 outwardly from said wire distal end, and a reduced-in-diameter  
7 collar radially fixed to said core wire proximate said distal  
8 end.



1           5.    A vascular filter guide wire according to claim 3  
2    wherein said strainer is formed to collapsibly engage said  
3    housing in a closed state and including:  
4            a plurality of radially spaced apart support struts  
5    defining a cage, said struts collapsibly hinged at one end along  
6    a common radial path on said shaft and interconnected through a  
7    woven peripheral mesh; and  
8            a biasing element interposed concentrically between  
9    said struts and said shaft to bias said struts radially  
10   outwardly in an open state.

1           6.    A vascular filter guide wire according to claim 5  
2    wherein:  
3            said spaced apart struts are disposed radially  
4    equidistant.

1           7.    A vascular filter guide wire according to claim 5  
2    wherein:  
3            said spaced apart struts are disposed in a spiral  
4    relationship.

1           8.    A vascular filter guide wire according to claim 5  
2    wherein:  
3            said struts are formed of a high elastic material.

1           9.    A vascular filter guide wire according to claim 5  
2    wherein:  
3            said woven mesh comprises a polymeric material.

1           10.  A vascular filter guide wire according to claim 5  
2    wherein:  
3            said woven mesh density is in the range 40 to 500  
4    micrometers.

1           11. A vascular filter guide wire according to claim 5  
2 wherein:

3                   said biasing element comprises a quad filar spring.

1           12. A vascular filter guide wire according to claim 1,  
2 further including a deployment/retraction mechanism including:  
3                   a removable base formed with a threaded passage for  
4 confining the proximal portion of said shaft; and  
5                   a manually rotatable control element, said control  
6 element formed with a threaded hollow shank and mounted to the  
7 proximal end of said wire, said control element operable to  
8 threadably engage said passage and incrementally urge relative  
9 axial displacement between said shaft and said wire to extend  
10 and retract said filter.

1           13. A vascular filter guide wire according to claim 1  
2 wherein said filter includes:  
3                   a cylindrical support cage having a closed distal end  
4 and a flared proximal end, said distal end fixed to the distal  
5 extremity of said shaft, and said proximal end extending axially  
6 and mounted to said core wire distal end; and  
7                   a continuous woven mesh having a plurality of  
8 longitudinal pleats and disposed within said support cage for  
9 straining particulate matter.

1           14. A vascular filter guide wire according to claim 13  
2 wherein:  
3                   said filter is formed with oppositely disposed cone-  
4 shaped ends to define said front and back halves.

1           15. A vascular filter guide wire according to claim 14  
2 wherein  
3                   said woven mesh is mounted to said cage back half.

1           16. A vascular filter guide wire according to claim 13  
2 wherein:  
3                   said woven mesh comprises a material from the group  
4 including stainless steel and nickel-titanium alloy.

1           17. A vascular filter guide wire according to claim 13  
2 wherein:  
3           said wire mesh density is in the range 40 to 500  
4 micrometers.

1           18. A vascular filter guide wire according to claim 1  
2 wherein said filter includes:  
3           a braid comprising a composite metallic/polymeric  
4 material, said material including  
5           a plurality of metallic filaments mounted to said  
6 respective shiftable shaft and core wire to define a  
7 support structure and  
8           a polymeric mesh interwoven with said metallic  
9 filaments to define a strainer.

1           19. A vascular filter guide wire according to claim 18  
2 wherein:  
3           said metallic filaments have respective common  
4 proximal and distal halves; and  
5           said polymeric mesh is interwoven in said distal half  
6 of said metallic filaments.

1           20. A vascular filter guide wire according to claim 18  
2 wherein:  
3           said metallic and polymeric filaments are woven at a  
4 ratio of approximately 1:4.

1           21. A vascular filter guide wire for directing precision  
2 placement of a catheter with respect to a lesion and filtering  
3 particulate matter dislodged by treatment of said lesion, said  
4 guide wire including:  
5           an actuating mechanism;  
6           an elongated flexible core wire having a proximal end  
7 attached to said actuating mechanism and a distal end for  
8 insertion and steering through a patient's vasculature to a  
9 position downstream of said lesion;  
10           a tubular flexible shaft slidably disposed along said  
11 core wire, said shaft including a proximal portion affixed to  
12 said actuating mechanism in movable relation to said wire, and a

13 distal portion disposed inwardly from the distal end of said  
14 core wire for placement downstream of said lesion;  
15 a locking mechanism to maintain said filter in an  
16 extended position during lesion treatment; and  
17 a collapsible filter coupled to said shaft distal  
18 portion, said filter including a collapsible support cage having  
19 respective front and back halves for slidably extending and  
20 retracting axially along said wire, said cage having a first end  
21 fixed to the distal extremity of said shaft, and an opposite end  
22 mounted to said core wire distal end, said strainer further  
23 including a continuous woven mesh disposed within said support  
24 cage for straining particulate matter and operable, in response  
25 to manual manipulation of said actuating mechanism to effect  
26 relative displacement between said shaft and said core wire, to  
27 radially extend outwardly within said vasculature and trap  
28 particulate matter arising from the treatment of said lesion.

1 22. A catheter system for treating a blood vessel lesion  
2 within a vasculature, said catheter system including:  
3 a catheter having a lesion treatment device; and  
4 a vascular filter guide wire for directing said  
5 balloon catheter to said lesion, said guide wire including a  
6 collapsible filter for manual deployment downstream of said  
7 balloon catheter to trap particulate matter arising from the  
8 treatment of said lesion.

1 23. A catheter system according to claim 22 wherein said  
2 vascular filter guide wire includes:  
3 an elongated flexible core wire having a proximal end  
4 and a distal end for insertion and steering through a patient's  
5 vasculature to a position downstream of said lesion;  
6 a tubular flexible shaft slidably disposed along said  
7 core wire, said shaft including a proximal portion and a distal  
8 portion disposed inwardly from said core wire distal end for  
9 placement downstream of said lesion; and  
10 a collapsible filter coupled at one end to said shaft  
11 and at its other end to said core wire, said filter operable in  
12 response to relative displacement between said shaft and said  
13 core wire, to radially extend outwardly within said vasculature

14 and trap particulate matter arising from the treatment of said  
15 lesion.

1 24. A method of filtering particulate debris from a  
2 vasculature caused by treatment of a lesion with a lesion  
3 treatment device, said catheter guided to the location of said  
4 lesion by a vascular filter guide wire having a core wire, a  
5 slidable shaft, and a manually collapsible filter mounted on the  
6 shaft and deployable upon relative displacement between said  
7 core wire and said shaft, said method including the steps of:  
8 guiding said vascular filter guide wire through said  
9 vasculature along a predetermined path to a lesion such that  
10 said filter is disposed downstream of said lesion;  
11 deploying said filter radially outwardly by shifting  
12 said shaft relative to said core wire;  
13 running said catheter over said guide wire along said  
14 predetermined path to position said lesion treatment device  
15 proximate said lesion;  
16 treating said lesion according to a predetermined  
17 procedure;  
18 maintaining said filter in a deployed position to trap  
19 particulate matter dislodged during said lesion treatment and  
20 prevent said matter from progressing downstream;  
21 withdrawing said catheter from said vasculature;  
22 retracting said filter radially inwardly by shifting  
23 said shaft back to said original position; and  
24 removing said guide wire from said vasculature.

1 25. A vascular filter for controllably expanding within a  
2 blood vessel to trap particulate matter loosened from a lesion,  
3 said filter responsive to relatively shiftable control elements  
4 to expand and retract, said filter including:  
5 a braid comprising a composite metallic/polymeric  
6 material, said material including  
7 a plurality of metallic filaments mounted to said  
8 respective shiftable shaft and core wire to define a  
9 support structure, and  
10 a polymeric mesh interwoven with said metallic  
11 filaments to define a strainer.

1           26. A vascular filter guide wire according to claim 25  
2 wherein:

3                   said metallic filaments have respective common  
4 proximal and distal halves; and  
5                   said polymeric mesh is interwoven in said distal half  
6 of said metallic filaments.

1           27. A vascular filter guide wire according to claim 25  
2 wherein:

3                   said metallic and polymeric filaments are woven at a  
4 ratio of approximately 1:4.

1           28. A method of fabricating a vascular filter, said method  
2 including the steps of:

3                   selecting a mandrel having a plurality of  
4 consecutively connected forms;  
5                   weaving a continuous layer of braid over said  
6 consecutively connected forms;  
7                   bonding said braid filaments at spaced apart sections  
8 between respective forms;  
9                   separating said respective braided forms at said  
10 bonded sections; and  
11                   removing said forms from said layer of braid.

1           29. A method of fabricating a vascular filter according to  
2 claim 28 wherein said step of weaving includes:

3                   forming a layer of braid over the proximal and distal  
4 halves of each form with a composite metallic/polymeric material  
5 to having a pic density sufficient to strain particulate matter.

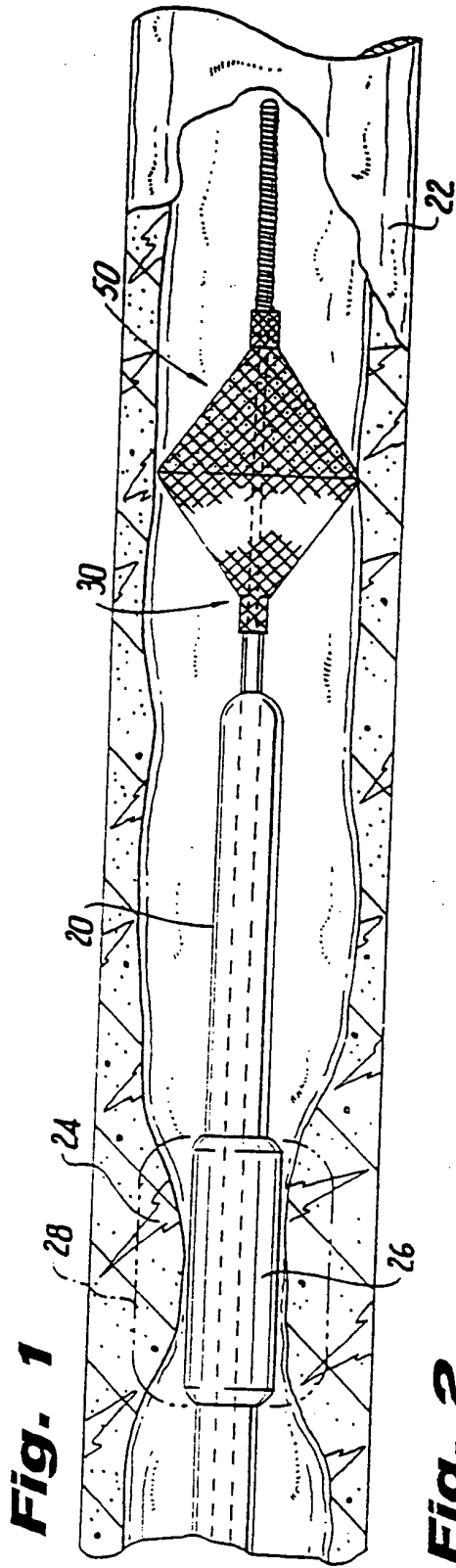
1           30. A method of fabricating a vascular filter according to  
2 claim 29 and further including the step of:

3                   cutting said polymeric filaments from said proximal  
4 halves of each form; and  
5                   fusing the ends of said cut filaments to form a  
6 collection cavity around each form.

1           31. A method of fabricating a vascular filter according to  
2 claim 28 wherein after said bonding step, said method further  
3 includes the steps of:

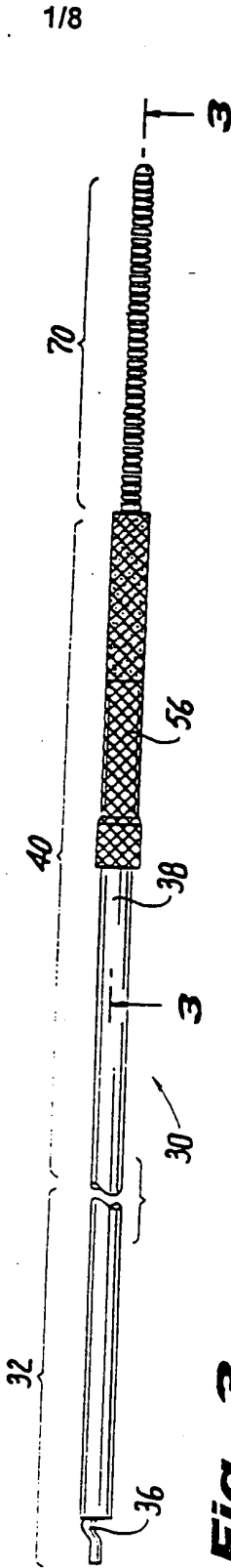
4 installing a filter layer over each form;  
5 weaving a second continuous layer of braid having a  
6 plurality of second braid filaments over said installed filters;  
7 and  
8 bonding said second braid filaments at said spaced  
9 apart sections.

1 32. A method of fabricating a vascular filter according to  
2 claim 28 wherein said forms are molded from a dissolvable  
3 material, said step of removing including:  
4 dissolving said forms by an appropriate solvent.



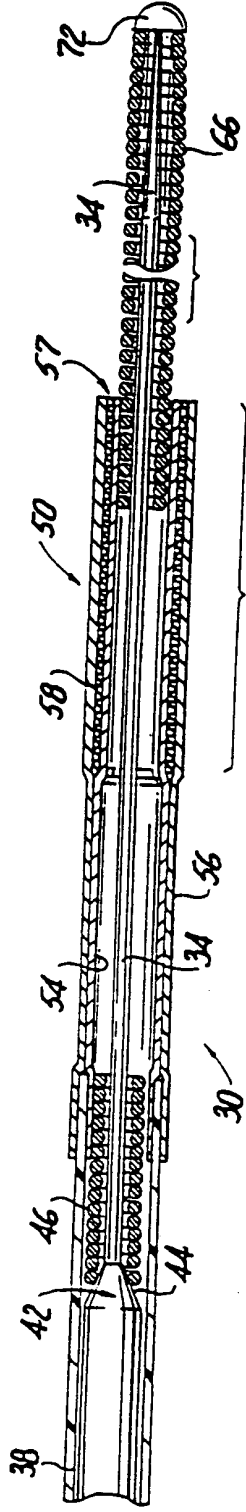
**Fig. 1**

**Fig. 2**

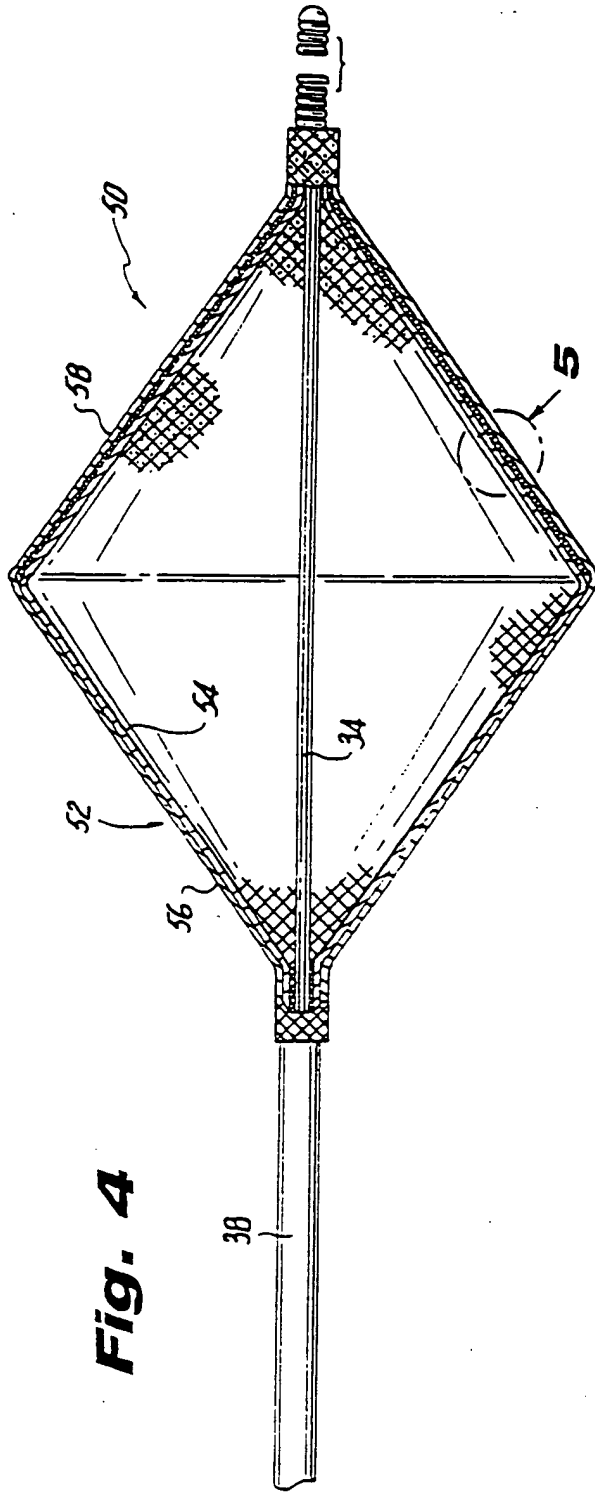


1/8

**Fig. 3**

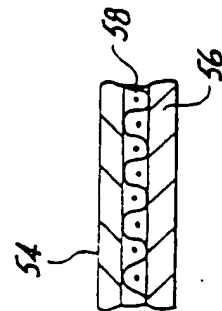
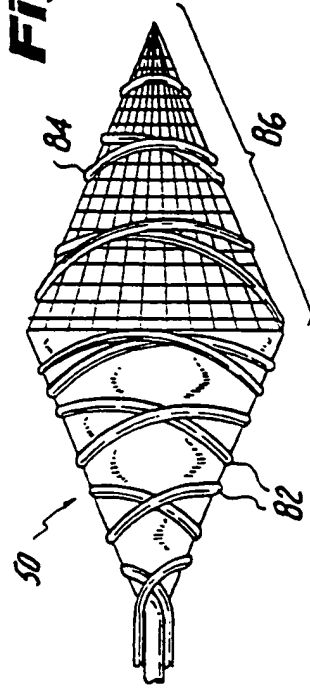






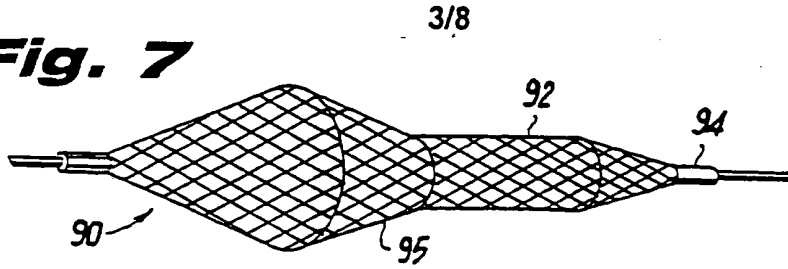
**Fig. 4**

**Fig. 6**

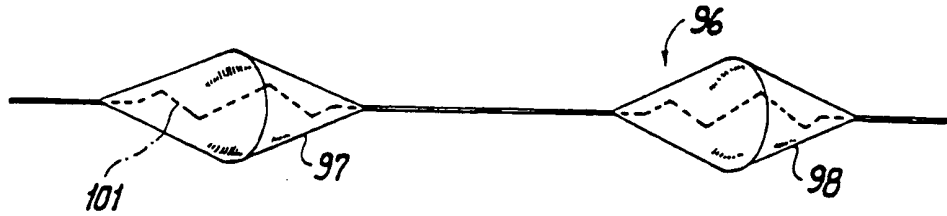


**Fig. 5**

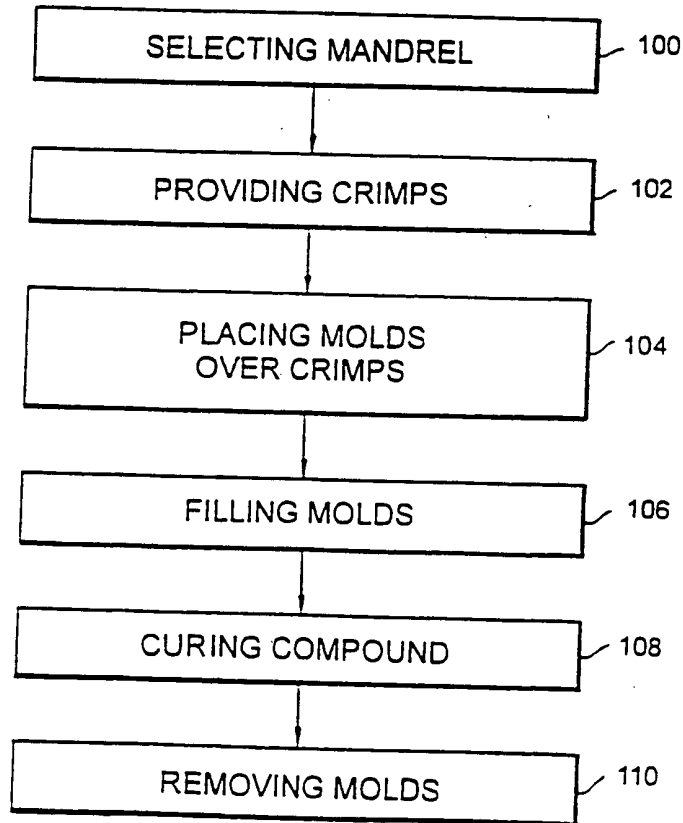
**Fig. 7**

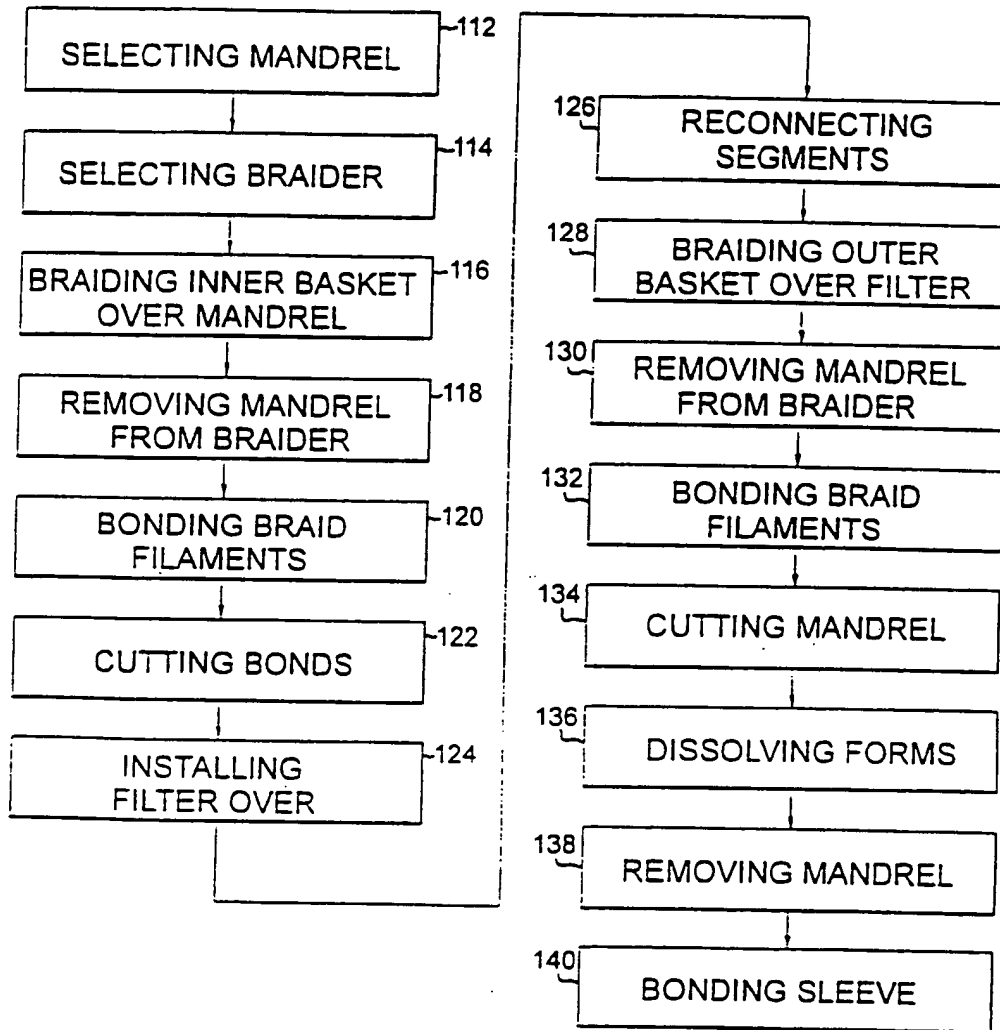


**Fig. 8**

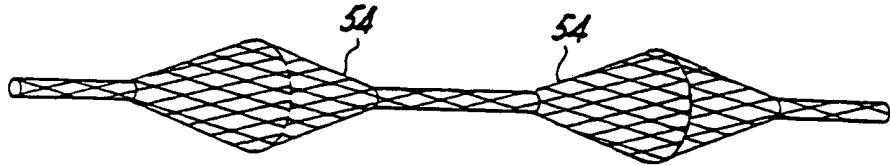


**Fig. 9**

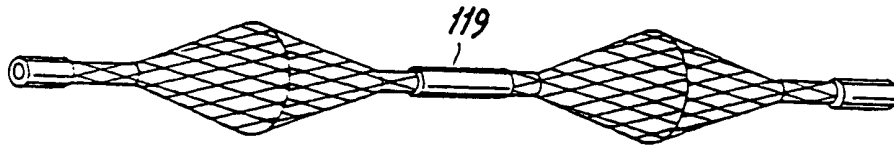




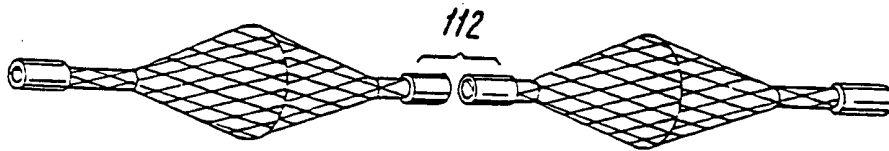
**Fig. 10**



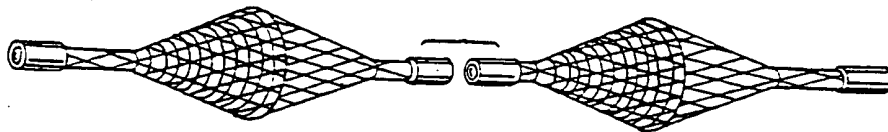
**Fig. 11a**



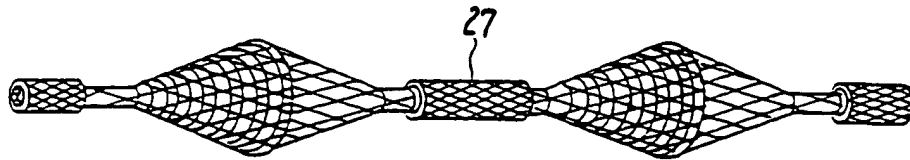
**Fig. 11b**



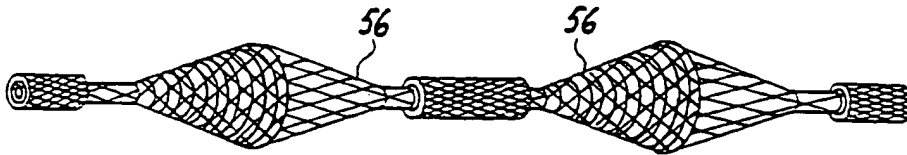
**Fig. 11c**



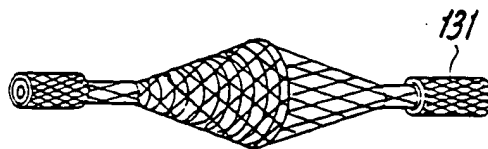
**Fig. 11d**



**Fig. 11e**



**Fig. 11f**



**Fig. 11g**

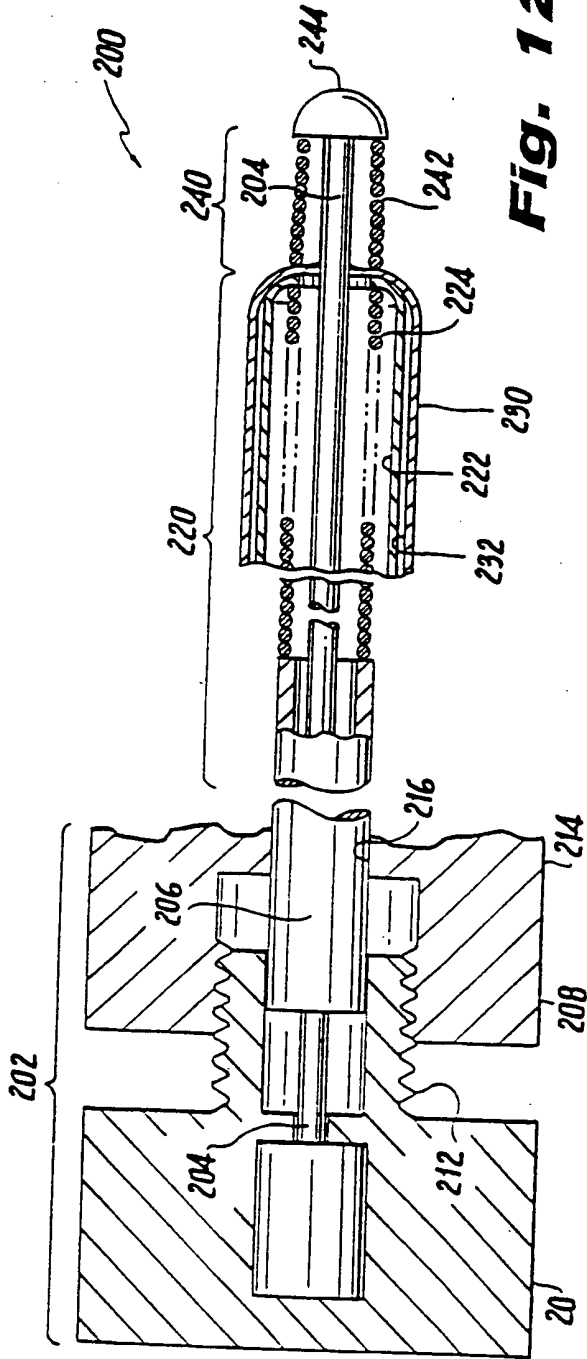


Fig. 12

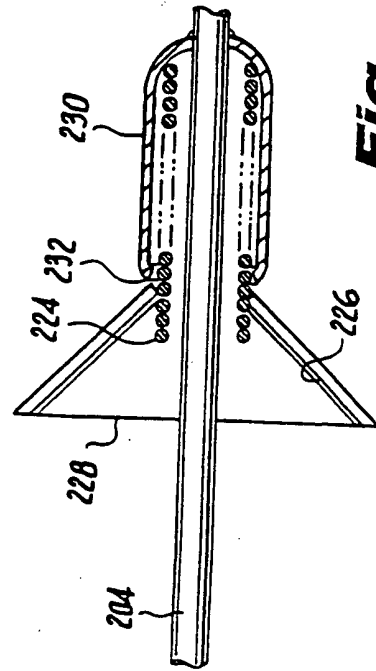
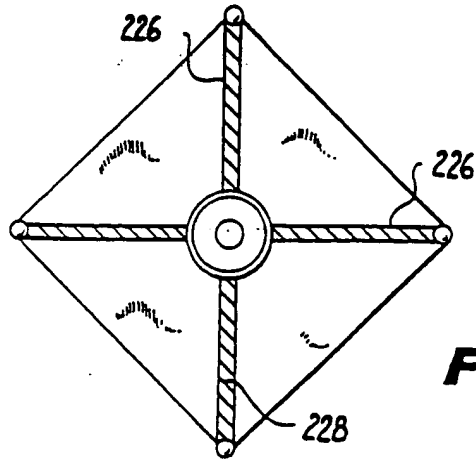
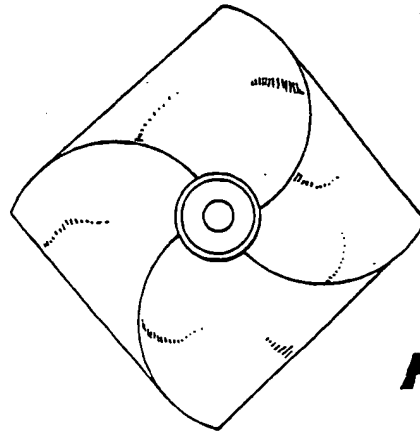


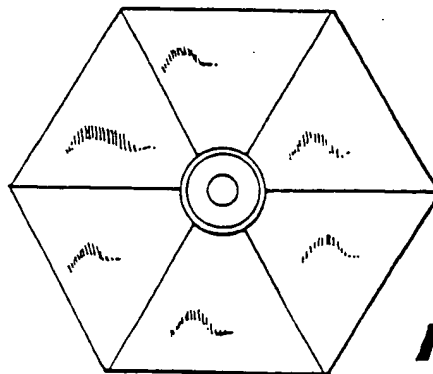
Fig. 13



**Fig. 14**



**Fig. 15**



**Fig. 16**

# INTERNATIONAL SEARCH REPORT

International Application No  
PCT/US 98/23516

**A. CLASSIFICATION OF SUBJECT MATTER**  
IPC 6 A61F2/01 A61M25/01

According to International Patent Classification (IPC) or to both national classification and IPC

**B. FIELDS SEARCHED**

Minimum documentation searched (classification system followed by classification symbols)  
IPC 6 A61F A61M

Documentation searched other than minimum documentation to the extent that such documents are included in the fields searched

Electronic data base consulted during the international search (name of data base and, where practical, search terms used)

**C. DOCUMENTS CONSIDERED TO BE RELEVANT**

Category *	Citation of document, with indication, where appropriate, of the relevant passages	Relevant to claim No.
X	US 4 926 858 A (BROWN PETER S ET AL) 22 May 1990	1, 21, 23
A	see column 5, line 34 - line 63; claims 5, 6, 10-15; figures 1-14	2, 12, 14, 24, 25
A	US 5 108 419 A (REGER VINCENT A ET AL) 28 April 1992 see abstract; figures	1-6, 13, 21-24
A	US 4 794 928 A (KLETSCSKA HAROLD D) 3 January 1989 see abstract; figures 12, 14	1, 21-24
A	EP 0 533 511 A (SCHMITZ RODE THOMAS) 24 March 1993 see abstract; figures 12, 13	1, 21-24
	-/--	

Further documents are listed in the continuation of box C.       Patent family members are listed in annex.

- \* Special categories of cited documents:
- \*A\* document defining the general state of the art which is not considered to be of particular relevance
  - \*E\* earlier document but published on or after the international filing date
  - \*L\* document which may throw doubts on priority claim(s) or which is cited to establish the publication date of another citation or other special reason (as specified)
  - \*O\* document referring to an oral disclosure, use, exhibition or other means
  - \*P\* document published prior to the international filing date but later than the priority date claimed
  - \*T\* later document published after the international filing date or priority date and not in conflict with the application but cited to understand the principle or theory underlying the invention
  - \*X\* document of particular relevance; the claimed invention cannot be considered novel or cannot be considered to involve an inventive step when the document is taken alone
  - \*Y\* document of particular relevance; the claimed invention cannot be considered to involve an inventive step when the document is combined with one or more other such documents, such combination being obvious to a person skilled in the art
  - \*Z\* document member of the same patent family

Date of the actual completion of the international search  11 February 1999	Date of mailing of the international search report  19/02/1999
---	--

Name and mailing address of the ISA European Patent Office, P.B. 5818 Patentlaan 2 NL - 2250 HV Rijswijk Tel. (+31-70) 340-2040, Tx. 31 651 epo nl, Fax: (+31-70) 340-3016	Authorized officer  Kanal, P
--	------------------------------------



INTERNATIONAL SEARCH REPORT

International Application No  
PCT/US 98/23516

C.(Continuation) DOCUMENTS CONSIDERED TO BE RELEVANT		
Category *	Citation of document, with indication, where appropriate, of the relevant passages	Relevant to claim No.
X	WO 96 01591 A (MICROVENA CORP) 25 January 1996	25
A	see page 29, line 15 - page 33, line 19; figures 11,12	1,18,21, 23,24, 26,28
A	FR 2 567 405 A (LEFEBVRE JEAN MARIE) 17 January 1986 see claims; figures	25
A	WO 95 34254 A (NADERLINGER EDUARD) 21 December 1995 see abstract; figures	1,21,23, 24
A	US 4 723 549 A (WHOLEY MARK H ET AL) 9 February 1988 cited in the application see abstract; figures	1,21-24

1

# INTERNATIONAL SEARCH REPORT

Information on patent family members

International Application No  
**PCT/US 98/23516**

Patent document cited in search report	A	Publication date	Patent family member(s)	Publication date
US 4926858	A	22-05-1990	AT 137098 T	15-05-1996
			CA 1255564 A	13-06-1989
			DE 3588104 D	30-05-1996
			DE 3588104 T	19-09-1996
			EP 0163502 A	04-12-1985
			EP 0352872 A	31-01-1990
			EP 0669106 A	30-08-1995
			JP 1894590 C	26-12-1994
			JP 6013036 B	23-02-1994
			JP 61056639 A	22-03-1986
			US 4781186 A	01-11-1988
			US 4979951 A	25-12-1990
US 5108419	A	28-04-1992	AU 8513091 A	17-03-1992
			WO 9203097 A	05-03-1992
			US 5160342 A	03-11-1992
US 4794928	A	03-01-1989	CA 1324552 A	23-11-1993
			AU 611182 B	06-06-1991
			AU 1991288 A	04-01-1993
			DE 3887896 D	24-03-1994
			EP 0371986 A	13-06-1990
			SU 1836115 A	23-08-1993
			WO 8809683 A	15-12-1988
EP 0533511	A	24-03-1993	DE 9109006 U	10-10-1991
WO 9601591	A	25-01-1996	CA 2194671 A	25-01-1996
			EP 0769926 A	02-05-1997
			JP 10504738 T	12-05-1998
			WO 9726939 A	31-07-1997
FR 2567405	A	17-01-1986	NONE	
WO 9534254	A	21-12-1995	DE 9409484 U	04-08-1994
			AT 170071 T	15-09-1998
			DE 59503357 D	01-10-1998
			EP 0765144 A	02-04-1997
			ES 2123258 T	01-01-1999
			US 5720764 A	24-02-1998
			US 4723549	A